

# VIKING

# TECHNICAL Practice

**TELECOM SOLUTIONS FOR THE 21ST CENTURY**

**W-1000, W-1000-EWP  
W-2000A and  
W-2000A-EWP  
Handsfree Doorboxes**

October 23, 2008

## Answer Your Door or Gate From Any Phone in Your Home or Business



W-1000/W-1000-EWP



W-2000A/W-2000A-EWP

Now you can answer your door or gate from the safety of your telephone! The **W-1000** (flush mount) and **W-2000A** (surface mount) doorboxes are designed to be installed on the unused telephone line input of nearly any phone system. One or two doorboxes can also share an existing residential phone line and provide door strike and CCTV camera control when used in combination with a **C-1000B** doorbox controller.

When the "Call" button is pressed, the doorbox generates a standard ring cadence for an adjustable number of rings. To converse with the visitor, the inside party simply answers the call from the phone of their choice.

For outdoor or harsh environments, the **W-1000** and **W-2000A** are available with Enhanced Weather Protection (**EWP**). The **W-1000-EWP** and **W-2000A-EWP** feature rubber gaskets and boots, closed cell foam gasketing, hand soldered silicon sealed connections, anti-corrosive gel filled butt connectors, as well as urethane encapsulated circuit boards with internally sealed, field-adjustable trim POTS and DIP switches.

**IMPORTANT:** In noisy locations requiring the push-to-talk feature, use the **W-3000**.

## Features

### W-1000/W-1000-EWP Features

- Vandal resistant, black powder painted, aluminum face plate with heavy duty metal call button and mounting gasket
- Flush mountable using included plastic rough-in box part # **259576**
- Surface mount with optional **VE-5x5** backbox

**?** Need More Information on VE-5x5? Call (715) 386-4345 and select 424.

### W-2000A/W-2000A-EWP Features

- Light gray colored, impact resistant, U.V. stable, plastic chassis
- Surface mountable only
- **New high output speaker amplifier with volume adjustment POT**
- Microphone volume adjustment POT
- 24 volt talk battery
- 20 Hz ring generator (3.0 REN ring load maximum)
- **Selectable number of rings (2, 3, 10 or 30)**
- Extended operating temperature range: -15°F to 130°F
- Compact 45° terminal strip for easy wiring
- **Optional Enhanced Weather Protection**

**?** Need More Information on EWP? Call (715) 386-4345 and select 859.

## Applications

- Commercial, industrial and residential door security
- Door or gate communication
- Use with the **C-1000B** controller for single line residential systems or when the operation of door strikes, gate openers or cameras are necessary

**?** Need More Information on the C-1000B? Call (715) 386-4345 and select 155.

Phone... 715.386.8861

## Specifications

**Power:** 120V AC/13.8V AC 1.25A UL listed adapter provided  
**Dimensions:** **W-1000** - Overall - 127 x 127 x 57 mm (5.0 x 5.0 x 2.25"), Plastic Electrical Box - 102 x 102 x 57mm (4 x 4 x 2.25"), **W-2000A** - 140 x 115 x 38mm (5.5" x 4.5" x 1.5")  
**Shipping Weight:** **W-1000** - 1.36 kg (3 lbs), **W-2000A** - .75 kg (1.5 lbs)  
**Standard W-1000/W-2000A Environment:** -26° C to 54° C (-15° F to 130° F) with 5% to 95% non-condensing humidity  
**W-1000-EWP/W-2000A-EWP Environment:** -26° C to 54° C (-15° F to 130° F) with up to 100% condensing humidity  
**Ringer Output:** 3.0 REN maximum, 20Hz  
**Ring Cadence:** 1 second ON, 3 seconds OFF  
**Maximum Loop Length:** 1.9 Km (6300 ft) - 24 AWG twisted pair  
**Maximum Power Run:** 45.7 m (150 ft) - 24 AWG twisted pair  
**Note:** Power run length may be increased, see **Wiring** sections  
**Speaker Volume:** Approximately 70db maximum @ 1m  
**Standard Connections:** (1) 4-position terminal block  
**EWP Connections:** (4) gel-filled butt connectors

## IF YOU HAVE A PROBLEM WITH A VIKING PRODUCT, PLEASE CONTACT: VIKING TECHNICAL SUPPORT AT (715) 386-8666

Our Technical Support Department is available for assistance Monday 8am-4pm and Tuesday through Friday 8am-5pm central time. So that we can give you better service, before you call please:

1. Know the model number, the serial number and what software version you have (see serial label).
2. Have your Technical Practice in front of you.
3. It is best if you are on site.

### RETURNING PRODUCT FOR REPAIR

The following procedure is for equipment that needs repair:

1. Customer must contact Viking's Technical Support Department at 715-386-8666 to obtain a Return Authorization (RA) number. The customer MUST have a complete description of the problem, with all pertinent information regarding the defect, such as options set, conditions, symptoms, methods to duplicate problem, frequency of failure, etc.
2. Packing: Return equipment in original box or in proper packing so that damage will not occur while in transit. Static sensitive equipment such as a circuit board should be in an anti-static bag, sandwiched between foam and individually boxed. All equipment should be wrapped to avoid packing material lodging in or sticking to the equipment. Include ALL parts of the equipment. C.O.D. or freight collect shipments cannot be accepted. Ship cartons prepaid to:  
**Viking Electronics, 1531 Industrial Street, Hudson, WI 54016**
3. Return shipping address: Be sure to include your return shipping address inside the box. We cannot ship to a PO Box.
4. RA number on carton: In large printing, write the R.A. number on the outside of each carton being returned.

### RETURNING PRODUCT FOR EXCHANGE

The following procedure is for equipment that has failed out-of-box (within 10 days of purchase):

1. Customer must contact Viking's Technical Support at 715-386-8666 to determine possible causes for the problem. The customer MUST be able to step through recommended tests for diagnosis.
2. If the Technical Support Product Specialist determines that the equipment is defective based on the customer's input and troubleshooting, a Return Authorization (R.A.) number will be issued. This number is valid for fourteen (14) calendar days from the date of issue.
3. After obtaining the R.A. number, return the approved equipment to your distributor, referencing the R.A. number. Your distributor will then replace the product over the counter at no charge. The distributor will then return the product to Viking using the same R.A. number.
4. **The distributor will NOT exchange this product without first obtaining the R.A. number from you. If you haven't followed the steps listed in 1, 2 and 3, be aware that you will have to pay a restocking charge.**

### WARRANTY

Viking warrants its products to be free from defects in the workmanship or materials, under normal use and service, for a period of one year from the date of purchase from any authorized Viking distributor or 18 months from the date manufactured, whichever ever is greater. If at any time during the warranty period, the product is deemed defective or malfunctions, return the product to Viking Electronics, Inc., 1531 Industrial Street, Hudson, WI, 54016. Customer must contact Viking's Technical Support Department at 715-386-8666 to obtain a Return Authorization (R.A.) number.

This warranty does not cover any damage to the product due to lightning, over voltage, under voltage, accident, misuse, abuse, negligence or any damage caused by use of the product by the purchaser or others.

Viking's sole responsibility shall be to repair or replace (at Viking's option) the material within the terms stated above. VIKING SHALL NOT BE LIABLE FOR ANY LOSS OR DAMAGE OF ANY KIND INCLUDING INCIDENTAL OR CONSEQUENTIAL DAMAGES RESULTING DIRECTLY OR INDIRECTLY FROM ANY BREACH OF ANY WARRANTY EXPRESSED OR IMPLIED, OR FOR ANY OTHER FAILURE OF THIS PRODUCT. Some states do not allow the exclusion or limitation of incidental or consequential damages, so this limitation may not apply to you.

THIS WARRANTY IS IN LIEU OF ALL OTHER WARRANTIES, EXPRESSED OR IMPLIED, INCLUDING THE WARRANTIES OF MERCHANTABILITY AND FITNESS FOR A PARTICULAR PURPOSE, WHICH ARE HEREBY EXCLUDED BEYOND THE ONE YEAR DURATION OF THIS WARRANTY. Some states do not allow limitation on how long an implied warranty lasts, so the above limitation may not apply to you.

## Installation

### A. Mounting the W-1000 and W-1000-EWP

The **W-1000** and **W-1000-EWP** are designed to be flush mounted to the included 4" x 4" x 2" deep plastic rough in box or surface mounted using optional Viking model **VE-5x5**. **Note: The W-1000/W-1000-EWP will NOT mount to a standard double gang box. The plastic rough in box (part # 259576) may be purchased separately. Go to [www.vikingelectronics.com](http://www.vikingelectronics.com) and click on "Spare Parts".**

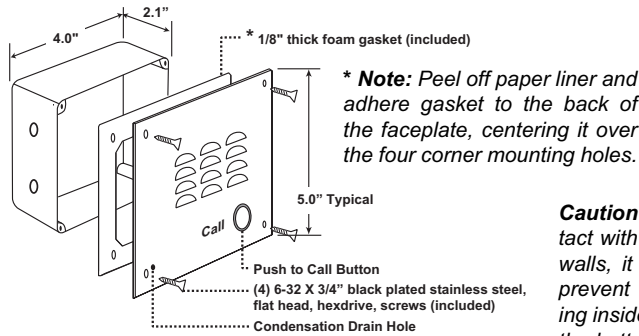
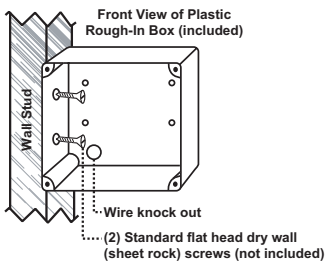

W-1000-EWP shown in VE-5x5 with Viking Model VE-GNP Gooseneck Pedestal

**Caution:** When warm air comes in contact with cold surfaces, such as outside walls, it causes condensation. To help prevent condensation from accumulating inside the **W-1000**, bring conduit into the bottom of the unit. If this is not possible, drill a 1/4" diameter hole in the bottom of the plastic rough-in box.

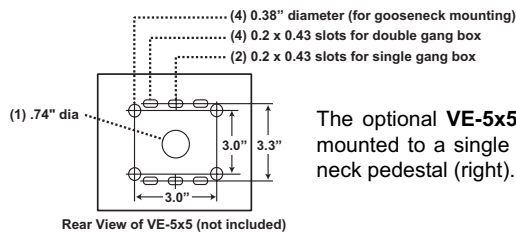
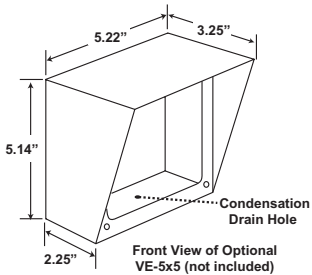

The optional **VE-5x5** Surface Mount Box is designed to be surface mounted to a single gang box, double gang box or **VE-GNP** gooseneck pedestal (right).

**Need More Information on VE-5x5 or VE-GNP? Call (715) 386-4345 and select 424.**

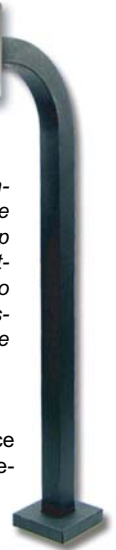

### B. Mounting the W-2000A and W-2000A-EWP

The **W-2000A** and **W-2000A-EWP** are designed to be surface mounted to a single gang box (not included), a standard 4" x 4" electrical junction box (not included), or directly to a wall or flat sided post.

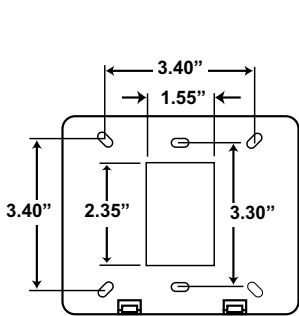

Front view of the W-2000A/W-2000A-EWP

Back panel of the W-2000A/W-2000A-EWP

Side view of the W-2000A/W-2000A-EWP

To open the speaker box, remove the two screws from the cover.

Mount back panel to a wall, a single gang box or a 4"x4" junction box with the arrow pointing up.

Attach the cover to the base with the two included screws as shown.

**Note:** For outdoor applications apply a bead of caulk between back panel and wall.

## C. Wiring the W-1000 and W-1000-EWP

**Important:** Do NOT install a W-1000 or W-2000A on a telephone line without a C-1000B Controller (Fax Back Document 155).

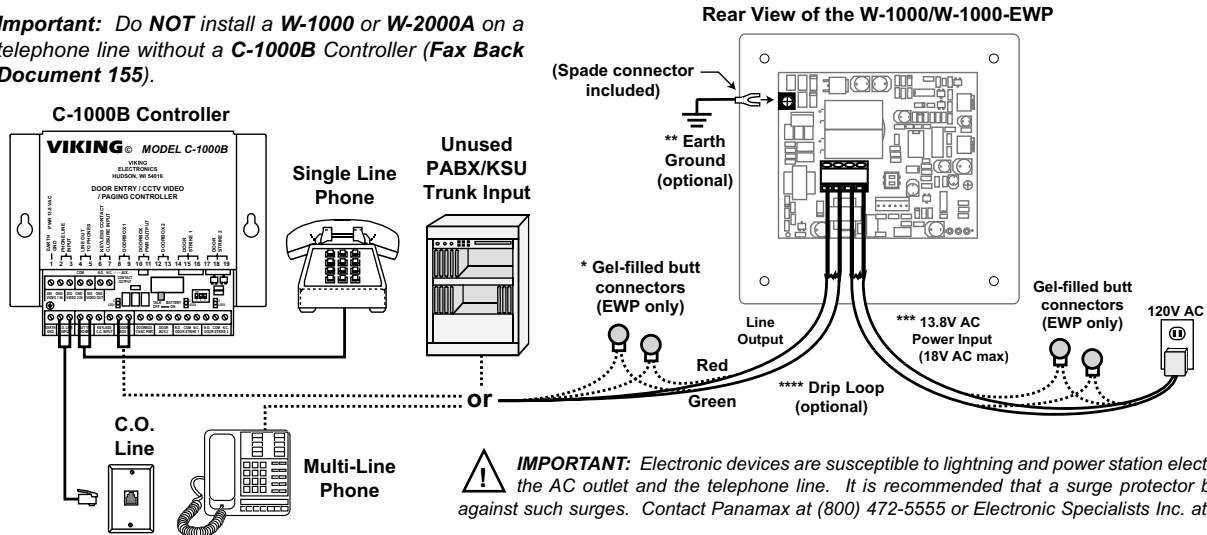

## D. Wiring the W-2000A and W-2000A-EWP

**Important:** Do NOT install a W-1000 or W-2000A on a telephone line without a C-1000B Controller (Fax Back Document 155).

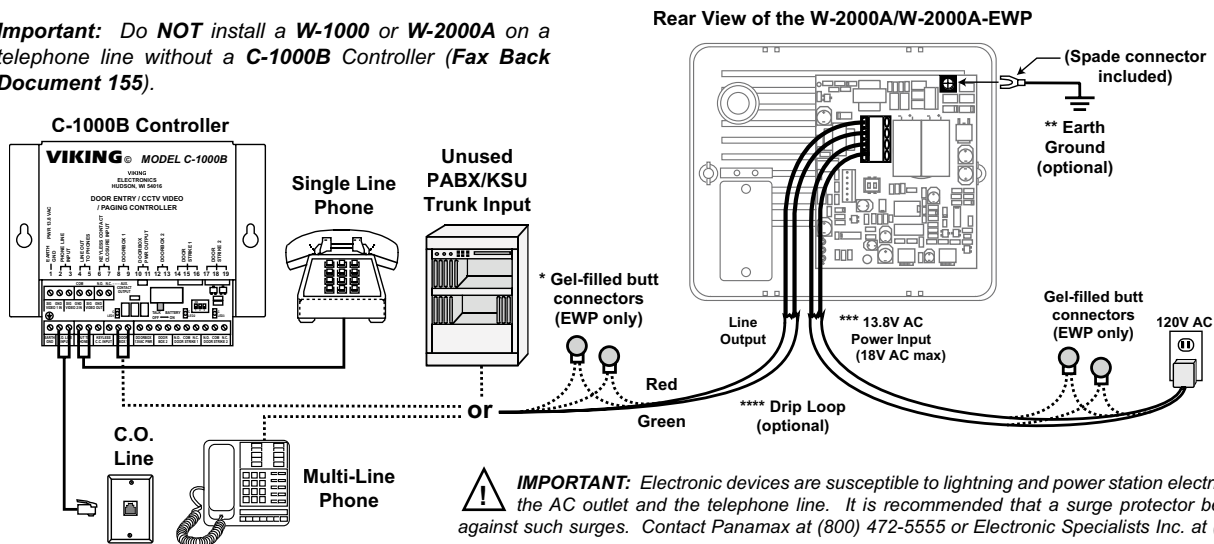

\* **Note:** The gel-filled (water-tight) butt connectors are designed for insulation displacement on 19-26 gauge wire with a maximum insulation diameter of 0.082 inches. Cut off stripped wire ends prior to terminating.

\*\* **Note:** To increase surge protection, loosen the PCB mounting screw labeled  $\oplus$  (as shown above) and fasten a wire with spade terminal (included) from the mounting screw to Earth Ground (grounding rod, water pipe, etc.)

\*\*\* **Warning:** The power run wire length is limited to 150 ft of 24 AWG wire. Longer power runs will require heavier gauge wire (doubling pairs) and/or a higher voltage power adapter. Power runs from 150 - 250 ft of 24 AWG wire are possible using a Radio Shack 18VAC adapter (part # 273-1690). Voltage at the doorbox power input connections must not exceed 18VAC RMS.

\*\*\*\* **Note:** When wires are routed from above, a "drip loop" is recommended to keep water away from the circuit board.

## Programming

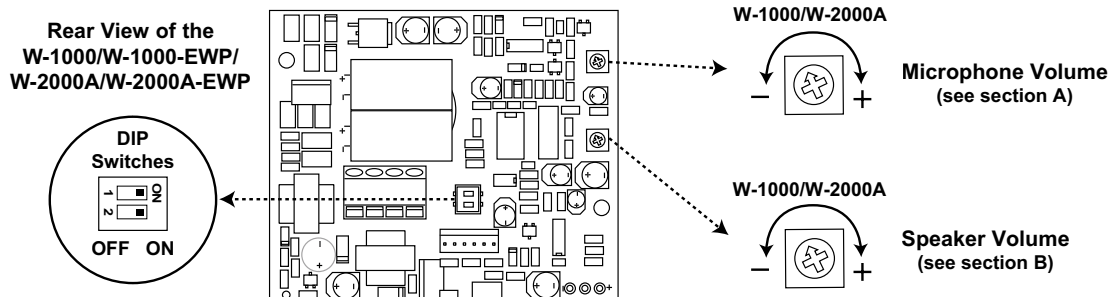

## A. Microphone Volume

In certain noisy locations (background traffic, machinery or wind), the microphone volume may need to be decreased. A symptom of this is one-way talk path, in which the distant party cannot be heard over the speaker. A "MIC VOL" adjustment is provided on the **W-1000/2000A** for increasing or decreasing the microphone volume. **Notes:** *If the microphone volume is set too high or too low, one-way talk path may occur. For extremely noisy environments, use the W-3000 in the "PUSH to TALK" mode.*

 Need More Information on W-3000?  
Call (715) 386-4345 and select 180.

## B. Speaker Volume

The **SPKR VOL** pot can be adjusted to increase or decrease the speaker volume to the level desired as shown above.

## C. Maximum Number of Rings

The maximum number of rings can be adjusted using the DIP switches. Use the chart at the right to adjust the maximum number of rings.

Sw 1	Sw 2	Maximum Rings
OFF	OFF	2 Ring
ON	OFF	3 Rings
OFF	ON	10 Rings
ON	ON	30 Rings

# Operation

In the idle state, the **W-1000** or **W-2000A** provides 24V DC talk battery. When the "Call" button is pressed, the **W-1000** or **W-2000A** generates a standard ring cadence (approximately 1 second ON and 3 seconds OFF) that is adjustable to 2, 3, 10 or 30 rings. When the call is answered, ringing will stop automatically and the calling party can converse handsfree (similar to a speakerphone) with the called party. The talk path will be maintained until the called party (inside phone) hangs up.

# Related Products

## C-1000B Door Entry Controller

The **C-1000B** allows single line phones or phone systems to share a phone line with one or two doorboxes or paging amplifiers. The **C-1000B** provides two Touch Tone controlled relays to operate door strikes or gate openers and provides doorbox triggered CCTV camera switching. Doorboxes and paging amplifiers can now be used on single line, residential or home office applications as well as on fully loaded systems, because they are no longer limited to installation on unused trunk ports. The **C-1000B** expands the potential installation sites for many peripherals such as doorboxes and paging amplifiers. For more information, see DOD# 155.



## SRC-1 Secure Relay Controller



The **SRC-1** enables a standard touch tone phone to securely operate a set of timed relay contacts to control a doorstrike or gate controller at a remote location. The **SRC-1** is fully user programmable and uses non-volatile memory. The **SRC-1** eliminates the possibility of dialing the activation code through the entry phone using a hand held touch tone dialer. The **SRC-1** is installed between the entry phone and the secure phone, and will reject touch tones from the entry phone and only operate the relay if the correct activation code (user programmable) is given from the secure phone. The **SRC-1** also provides up to 32 keyless entry codes to operate the relay from the entry phone with 1 to 6 digits. This feature can be disabled in programming for increased security. For more information, see DOD# 409.

## Add Paging and Door Chimes with an SLP-1

The **SLP-1** Single Line Paging controller will allow you to page family members or co-workers from any phone in your home or small office. The pages can be heard over the same speakers that are installed for music distribution. The **SLP-1** connects in series with a single existing phone line. The unit has a built-in 2 watt amplifier, pre-amp output, music on hold input, intercom features and selectable loud ringing. The **SLP-1** provides an input for a lighted doorbell switch, allowing a door chime to be heard over existing speakers. Page from several different phone lines by connecting multiple units. For more information, see DOD# 478.



**Product Support Line...715.386.8666**

**Fax Back Line...715.386.4345**

Due to the dynamic nature of the product design, the information contained in this document is subject to change without notice. Viking Electronics, and its affiliates and/or subsidiaries assume no responsibility for errors and omissions contained in this information. Revisions of this document or new editions of it may be issued to incorporate such changes.